

HYTEK ATEX APPROVED TANK ALARM

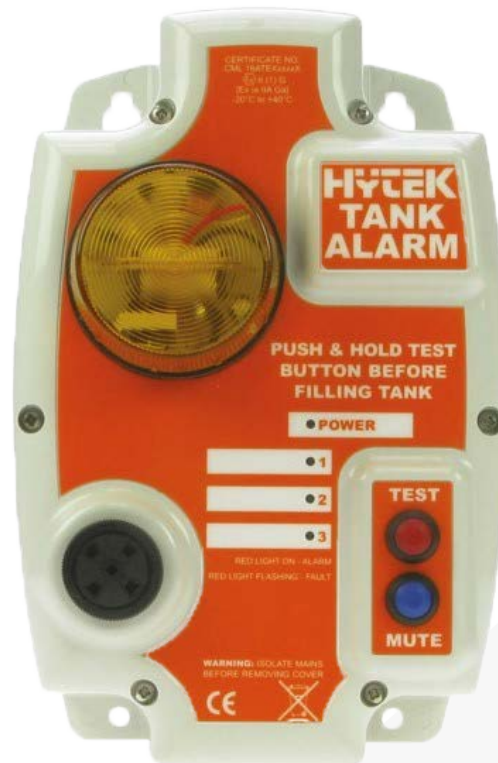

Applies to the following models **ONLY**:

TA3A...

.P	.PR	.B	.BR
-----------	------------	-----------	------------

Please read carefully **BEFORE** commencing installation.

Registered Office: HYTEK (GB) LIMITED,
Delta House, Green Street, Elsenham, Bishop's Stortford,
CM22 6DS UK.

Registered in England No. 1915382

Tel: +44 (0) 1279 815 600

Email: info@hytekgb.com

ENVIRONMENTAL INFORMATION

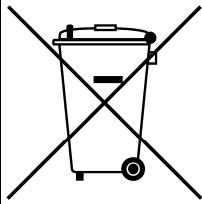

UK Regulation S1 2013 3113 requires that the equipment bearing this symbol on the product and/or its packaging must not be disposed of with unsorted municipal waste. The symbol indicates that this product must be disposed of separately from regular household waste streams. It is your responsibility to dispose of this and other electric and electronic equipment via designated collection facilities appointed by the government or local authorities.

PRODUCT DESCRIPTION



The Hytek Tank Alarm is designed to provide visual and audible alarms whenever a predetermined level in a storage tank is reached.

The system consists of a maximum of three-weighted float switches and an enclosure weatherproof to an IP54 standard which contains the visual and audible alarms and the electronic PCB.

This alarm is approved to operate with flammable liquids classed as category 1, 2 or 3 in accordance with European Regulation No. 1272/2008. It is ATEX certified in accordance with EN 60079-0 and EN 60079-11. It is also IECEx certified in accordance with IEC 60079-0 and IEC 60079-11.

The alarm box, featuring the warning devices and test/mute buttons, must be located outside any hazardous zone and bears the following certification marking and number:

CML16ATEX2355X
IECEX CML 16.0128X

 II 1 G
[Ex ia IIA Ga]
-20°C to +40°C
 2776

The float sensor(s) can be located in hazardous zones 0,1 or 2 and bears the following certification marking and number:

CML 16ATEX2355X
IECEX CML 16.0128X
CML 16ATEX2356X
IECEX CML 16.0129X

 II 1 G
Ex ia IIA T3 Ga
-20°C to +40°C

CONDITIONS OF CERTIFICATION

1. Due to safety critical internal creepage and clearance distances in the control unit, if installed in a location other than a clean and dry environment, the user shall ensure that the control unit is additionally provided with protection having an ingress protection rating of at least IP54 and is maintained throughout the lifetime of the equipment.
2. The float switch incorporates an isolated metal part which could become either charged in use or be a discharge point for charged liquids upon filling or emptying. The float switch shall only be used in applications where static generated via contact liquids are controlled so not to be considered an ignition source.
3. The relay contacts in normal operation shall not switch more than 5Amps, 250Vrms or 100VA in accordance with IEC 60079-11.
4. Where applicable, only alkaline batteries of the same make shall be used as replacements. All batteries shall be replaced at the same time.

IMPORTANT WARNING NOTES

1. This alarm is designed for use with liquids classed as category 1, 2 or 3 in accordance with European Regulation No. 1272/2008, including petrol, diesel, gas oil, water, hydraulic oil and heating oil. It can be used with Anti-freeze or AdBlue[®] if the optional stainless-steel float switch assembly is fitted.
2. The alarm box featuring the warning devices and test/mute buttons must not be installed in a hazardous zone or below ground level. The float sensor can be located in zones 0, 1 or 2 with the supplied connecting wire running to the alarm box.
3. The user must ensure that chemicals present in the atmosphere do not affect the performance or degrade the polycarbonate enclosure.
4. Only the correct ATEX/IECEx certified float switches supplied by Hytek can be used with the Tank Alarm.
5. Installation of this equipment and its associated tank, pipe work and fittings should only be carried out by qualified fuel installation engineers.

6. The installation must be carried out in accordance with the requirements of EN 60079-14 the latest relevant electrical and local authority regulations and standards.
7. It must not be used with any liquids or applications other than those specified. We will accept no warranty claims or liability if it is used for other liquids or applications.
8. This product must not be used if it is damaged.

SPECIFICATION

MAINS VERSION

- 230V 3-channel alarm.
- IP54 weatherproof enclosure, for outside mounting.
- Each channel can be used as an overflow, low level or bund alarm.
- High power alarm sounder.
- High visibility flashing zenon beacon.
- Test button checks float switches as well as beacon & sounder.

BATTERY VERSION

- Battery 3 channel alarm.
- Each channel can be used as an overflow, low level or bund alarm.
- High power alarm sounder.
- No zenon beacon, but individual channel LED's.
- Test button checks float switches as well as batteries & sounder.
- Battery life depends on number of test & alarm incidents.

INSTALLATION INSTRUCTIONS

MOUNTING

The float switch assembly is supplied with 5 metres of 2-core PUR fuel resistant cable that may be extended, as necessary, up to 100 metres.

1. Remove front display lid from alarm box and disconnect ribbon cable. Place the lid somewhere clean and safe.
2. Using wall-mounting bracket, fix alarm box into position.
3. Self-adhesive product labels are supplied and are to be fixed alongside the corresponding channel LED indicator on the front of the alarm unit.

POWER SUPPLY

4. The TA3A.P and TA3A.PR are designed to have a continual 230V AC supply fused at a rating of 6 amps max. The TA3A.B and TA3A.BR have an internal battery power supply. See Connections diagram.

CONNECTIONS DIAGRAM

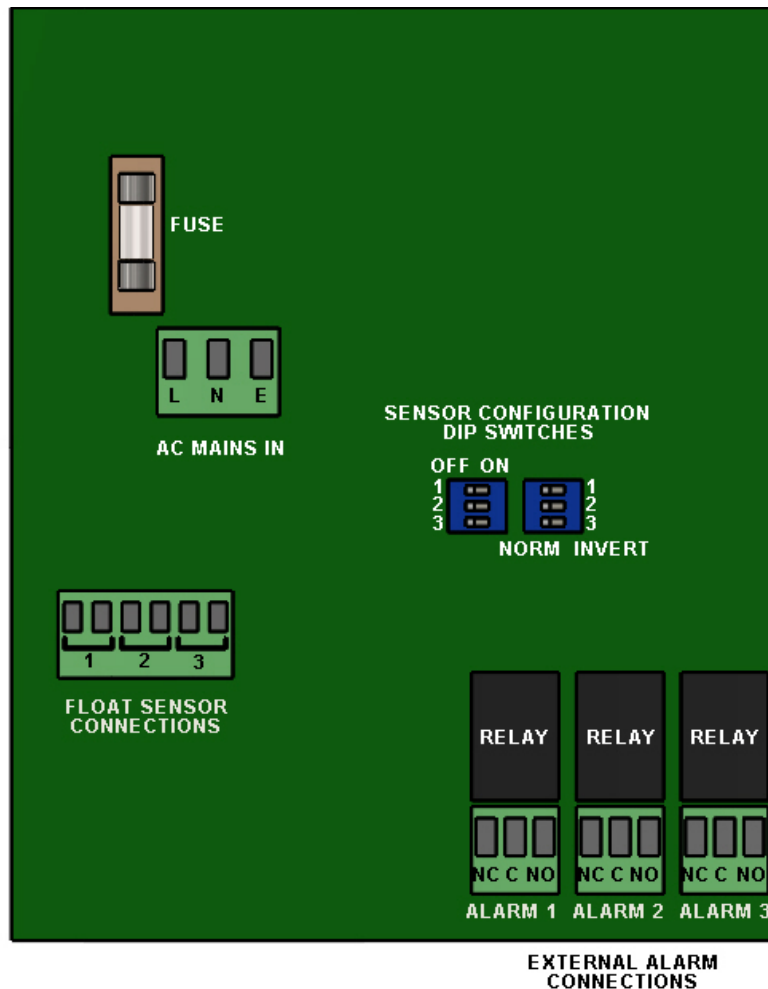

FLOAT SWITCH INSTALLATION

5. To ensure the float switch is positioned at the correct depth in the tank, locate the gland, fitted to the gland plate, at the appropriate point along the float switch cable.

Carefully install float switch through a 30mm hole in the top of the tank, ensuring the sealing gasket is in place. Secure the gland plate to the tank using two self-tapping screws (not supplied). See Float switch installation diagram. Alternatively, for steel tank installations, an optional 1 1/2" brass cap (Hytek order ref - TA.CAP) can be used.

NB: Installation of the float switch should be as far away from the fill point of the tank as possible.

FLOAT SWITCH INSTALLATION DIAGRAM

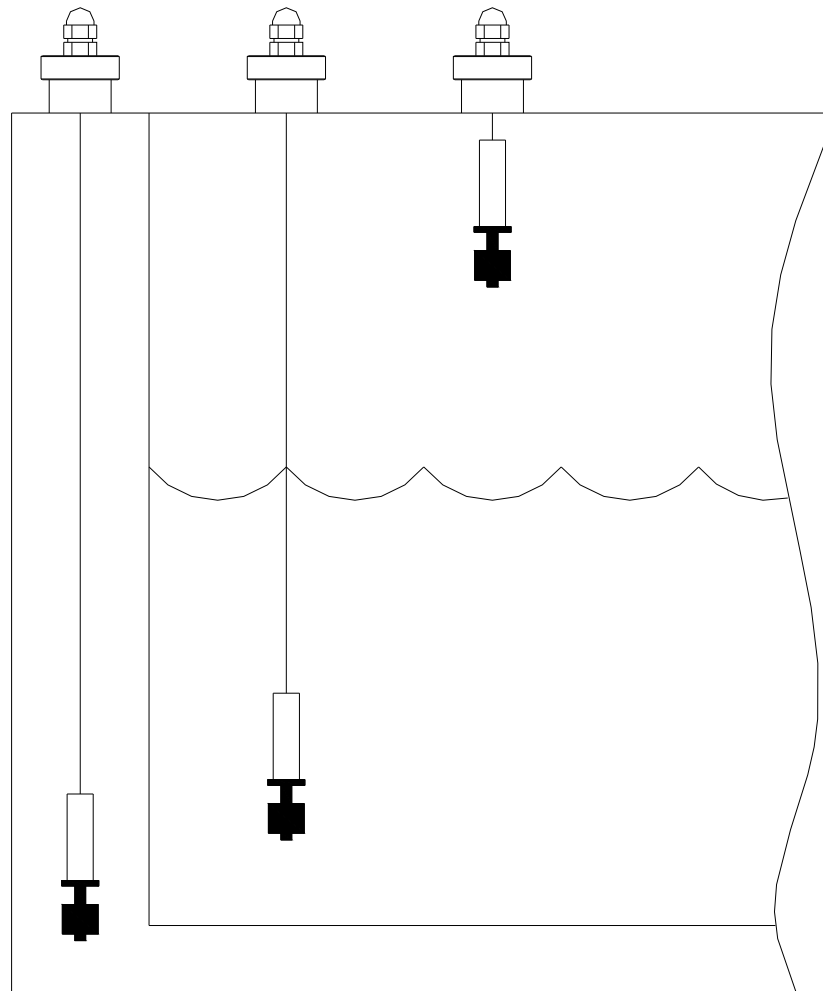

FLOAT SWITCH ACTIVATION AND CONFIGURATION

6. Connect the float switch cables to the float switch terminals inside the alarm box as per connections diagram.
7. After connecting the desired amount of float switches, activate the corresponding channels by setting the appropriate channel activation dipswitch to "ON" position. See Dip switch settings diagram.

NB: If a channel activation dipswitch is in the "OFF" position and a float switch connected to the corresponding terminals is operated, the alarm will not function.

8. Set the high/low level dipswitches to the appropriate position (NORM = high level activation, INVERT = low level activation) to enable the corresponding float switches to detect either a high or low-level situation. See Dip switch settings diagram.

DIPSWITCH SETTINGS DIAGRAM

CHANNEL ACTIVATION

OFF **ON**

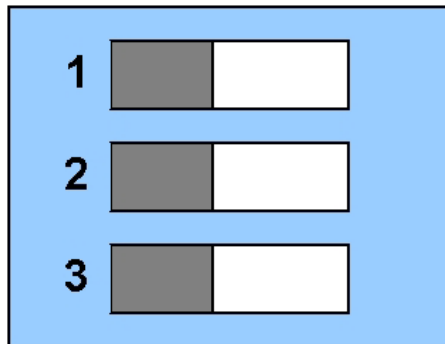

FLOAT SWITCH SETTING

NORM **INVERT**
(HIGH LEVEL) (LOW LEVEL)

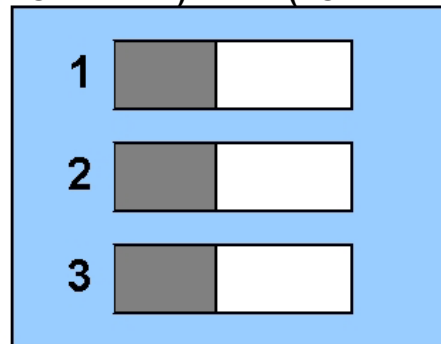

EXTERNAL RELAY OUTPUTS

9. Where external output relays have been fitted connect external cabling as per connections diagram. The relay contacts are rated at 250 volts, 5 amps / 100VA max.

NB: The relays are a switch only and do not offer a power source for any external equipment. The relays **MUST NOT** be used to activate any equipment such as fuel pumps or safety valves.

COMPLETION OF INSTALLATION

10. Install batteries provided (TA3A.B & TA3A.BR Only).
11. Refit lid to alarm box ensuring that ribbon cable is reconnected to the main PCB and the lid seal is in place.
12. Switch on power. The green "POWER" LED should illuminate (TA3A.P, TA3A.PR only).

OPERATION

POWER STATUS

MAINS VERSION: The Power LED will remain illuminated to indicate that there is mains power to the unit

BATTERY VERSION: The Battery LED will flash every 2 seconds to indicate that there is battery power to the unit. If the battery charge is too low, then the sounder will activate intermittently to indicate this.

ALARM CONDITION

When a high or low-level alarm condition occurs the corresponding channel LED on the tank alarm lid is illuminated and the sounder/beacon will activate. The external relay will also be activated.

FLOAT SWITCH FAULT INDICATION

If any of the channel LEDs flashes repeatedly then this indicates a fault with the float switch.

ALARM MUTE

Pressing the mute button for 1.5 seconds will silence the sounder when an alarm condition is occurring, the beacon will continue to flash until the alarm condition has been rectified. This will not de-activate any relays (if fitted). The relays will only be de-activated when float switch returns to its normal position.

If the mute button is not depressed the sounder will silence after 20 minutes leaving the beacon and channel LED on.

The channel LED will remain on until the alarm condition has been rectified (float switch returns to its normal position).

ALARM TEST

To test the Tank Alarm, push and hold the test button on the lid. If the Tank Alarm is functioning correctly the sounder should activate, the beacon will flash (if fitted) and all activated channel LEDs will illuminate.

If any of the channel LEDs flashes repeatedly then this indicates a fault with the float switch.

***Battery version:** If no sounder is heard and no channel LED's illuminate, check batteries and change as necessary.*

NB: Always push the Tank Alarm test button before filling the tank.

FITTING DIMENSIONS

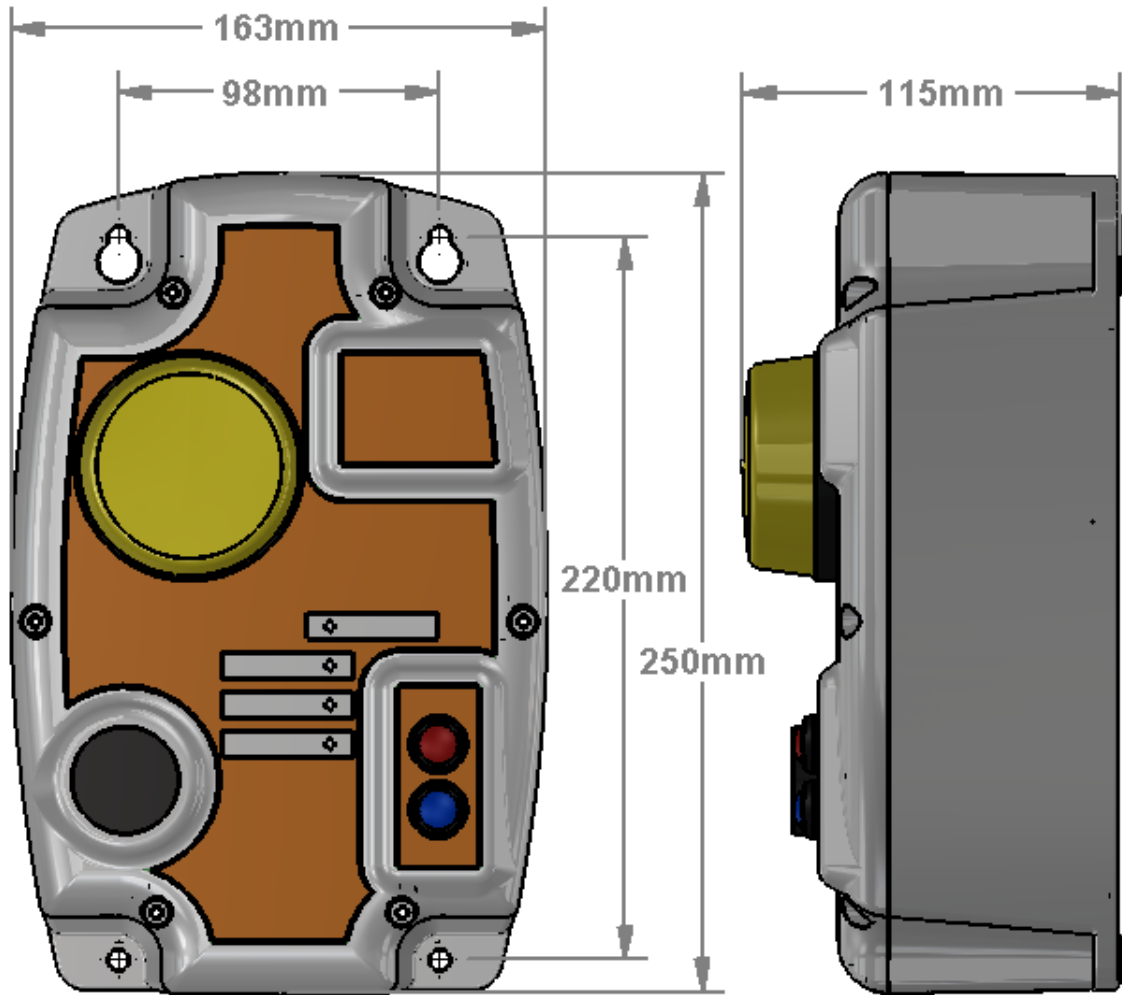

PARTS LIST

HYTEK TANK ALARM PARTS LIST

REF.	PART NUMBER	PART DESCRIPTION
1▼	TA3A.LID	Tank alarm lid with all components - MAINS
▶	TA3A.LID.BAT	Tank alarm lid with all components - BATTERY
2	TA.BEACON	Tank alarm amber beacon
3▼	TA3A.LABM	Display lid label (mains)
▶	TA3A.LABB3	Display lid label (battery)*
4	TA.SOUND	Tank alarm sounder
5	TC.AT	Tank alarm test button
6	TC.AS	Tank alarm mute button
7	TA.GLND	Cable gland PG7*
8	TA3A.BOX	Tank alarm box (base only)
9▼	TA3A.PCBMR	Alarm PCB 230Vac with Relays*
▶	TA3A.PCBM	Alarm PCB 230Vac*
▶	TA3A.PCBR	Alarm PCB 6Vdc Battery with Relays*
▶	TA3A.PCBB	Alarm PCB 6Vdc Battery*
10	TA.CONM	Plug connector (230/110v mains)*
11	TA.CONR	Plug connector (relays)*
12	TA.CONF	Plug connector (floats)*
13	TA3A.BLANK	12.7mm hole blank *
14	TA.LABP	Product label (9 labels per sheet) *
15	TA.PCBDISP	Alarm display PCB*

*not shown

SPARES

PART NUMBER	DESCRIPTION
TA.FA5	5m universal float switch
TA.FA10	10m universal float switch
TA.FA.SS5	5m stainless steel float switch
TA.CAP	1 ½" threaded brass cap for steel tanks
TA.CABLE	Extra cable to extend float switches
TA.CABEXT	Use to join extra cable - IP68 rated
TA.BATTERY	Type D battery (4 per unit)

OUTSIDE VIEW

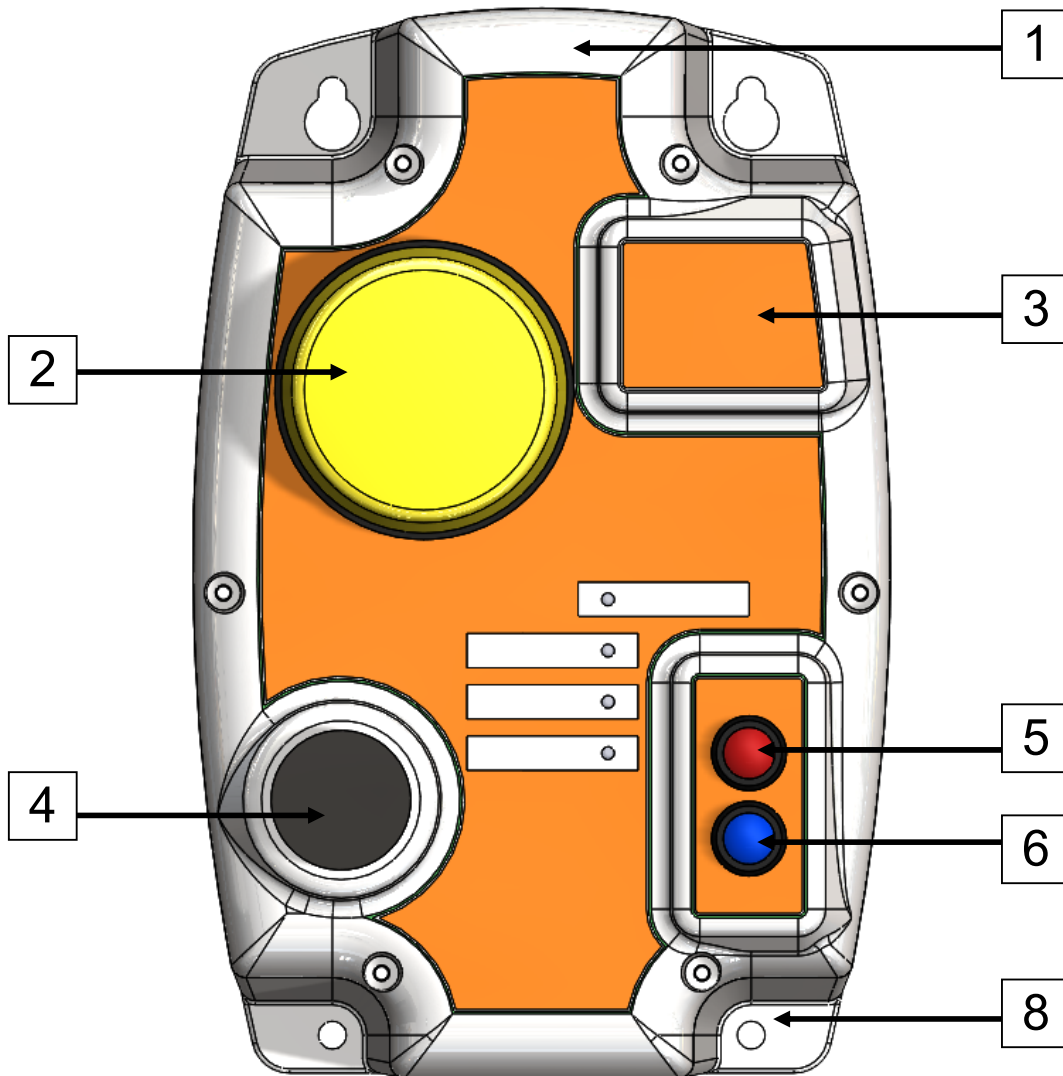

TA3A.P (230V AC) - SHOWN

UK/EU DECLARATION OF CONFORMITY



Company Name: **Hytek (GB) Ltd**

Address: **Delta House, Green Street, Elsenham
Bishop's Stortford, Hertfordshire, CM22 6DS**

Date of Issue: **21st August 2023**

Equipment Details: **EX Tank Alarm and Day Tank Controller Including Float Sensor**
TA3A.P, TA3A.PR, TA3A.B, TA3A.BR, TA3A.DTC.P, TA3A.DTC.B, TA.FAxxx range

Applicable Directives: **S1 2016 1091 Electromagnetic Compatibility Regulations**
& Standards **2014/30/EU EMC Directive**
EN 61326-1:2013 - Electromagnetic compatibility (EMC) – Group 1, Class B Eq. (Emissions)
EN 61326-1:2013 - Electromagnetic compatibility (EMC) – Industrial Environment (Immunity)

SI 2016 1101 Electrical Equipment Safety Regulations
2014/35/EU Low Voltage Directive

SI 2008 1597 Supply of Machinery Safety Regulations
2006/42/EC Machinery Directive

SI 2013 3113 Waste Electrical & Electronic Equipment Regulations
2012/19/EU Waste Electrical & Electronic Equipment Regulations



SI 2012 3032 Restriction of Use of Certain Hazardous Substances Regulations
2011/65/EU Restriction of Hazardous Substances Directive (RoHS2)

2014/34/EU ATEX Directive
ATEX - EN 60079-0 and EN 60079-11
IECEX - IEC 60079-0 and IEC 60079-11

EU Type examination Certificate

Number: CML 16ATEX2355X
IECEX CML 16.0128X
Issued by Notified Body: CML Ltd. Number CML 2503
Unit 1 Newport Business Park,
New Port Road, Ellesmere Port, CH65 4LZ UK

Marking:

Alarm Box:	Float Sensor:
CML16ATEX2355X	CML 16ATEX2355X
IECEX CML 16.0128X	IECEX CML 16.0128X
 II 1 G	CML 16ATEX2356X
[Ex ia IIA Ga]	IECEX CML 16.0129X
-20°C to +40°C	 II 1 G
 2776	Ex ia IIA T3 Ga
	-20°C to +40°C

Notified Body Issuing QA: CML B.V Number 2776
Notification Certificate Chamber of Commerce No 6738671
Hoogoorddreef 15, Amsterdam, 1101 BA,
The Netherlands

Declaration Number: **UK130 Issue 9**

On behalf of the above-named company, I declare under our sole responsibility that, on the date the equipment accompanied by this declaration is placed on the market, the equipment conforms with all technical and regulatory requirements of the above listed directives.

Clive Wellings, Process Co-ordinator, 21st August 2023, Bishop's Stortford, Herts

THE INFORMATION CONTAINED IN THIS DOCUMENT IS PROTECTED BY COPYRIGHT © AND PROPERTY LAWS AND IS THE SOLE PROPERTY OF HYTEK (GB) LTD. ANY REPRODUCTION IN PART OR AS A WHOLE WITHOUT THE WRITTEN PERMISSION OF HYTEK (GB) LTD IS PROHIBITED